

▶ BSE792220B  
BSE792220M

EN **User Manual**  
Steam oven

# USER MANUAL



**AEG**

## CONTENTS

1. SAFETY INFORMATION.....	2
2. SAFETY INSTRUCTIONS.....	4
3. PRODUCT DESCRIPTION.....	7
4. CONTROL PANEL.....	8
5. BEFORE FIRST USE.....	10
6. DAILY USE.....	11
7. CLOCK FUNCTIONS.....	22
8. AUTOMATIC PROGRAMMES.....	23
9. USING THE ACCESSORIES.....	24
10. ADDITIONAL FUNCTIONS.....	26
11. HINTS AND TIPS.....	27
12. CARE AND CLEANING.....	52
13. TROUBLESHOOTING.....	56
14. ENERGY EFFICIENCY.....	59

## FOR PERFECT RESULTS

Thank you for choosing this AEG product. We have created it to give you impeccable performance for many years, with innovative technologies that help make life simpler - features you might not find on ordinary appliances. Please spend a few minutes reading to get the very best from it.

Visit our website for:



Get usage advice, brochures, trouble shooter, service information:

**[www.aeg.com/webselfservice](http://www.aeg.com/webselfservice)**



Register your product for better service:

**[www.registeraeg.com](http://www.registeraeg.com)**



Buy Accessories, Consumables and Original spare parts for your appliance:

**[www.aeg.com/shop](http://www.aeg.com/shop)**

## CUSTOMER CARE AND SERVICE

Always use original spare parts.

When contacting our Authorised Service Centre, ensure that you have the following data available: Model, PNC, Serial Number.

The information can be found on the rating plate.

 Warning / Caution-Safety information

 General information and tips

 Environmental information

Subject to change without notice.

### 1. SAFETY INFORMATION

Before the installation and use of the appliance, carefully read the supplied instructions. The

manufacturer is not responsible for any injuries or damage that are the result of incorrect installation or usage. Always keep the instructions in a safe and accessible location for future reference.

## 1.1 Children and vulnerable people safety

- This appliance can be used by children aged from 8 years and above and persons with reduced physical, sensory or mental capabilities or lack of experience and knowledge if they have been given supervision or instruction concerning the use of the appliance in a safe way and understand the hazards involved.
- Children between 3 and 8 years of age and persons with very extensive and complex disabilities shall be kept away from the appliance unless continuously supervised.
- Children of less than 3 years of age should be kept away from the appliance unless continuously supervised.
- Do not let children play with the appliance.
- Keep all packaging away from children and dispose of it appropriately.
- Keep children and pets away from the appliance when it operates or when it cools down. Accessible parts may become hot during use.
- If the appliance has a child safety device, it should be activated.
- Children shall not carry out cleaning and user maintenance of the appliance without supervision.

## 1.2 General Safety

- Only a qualified person must install this appliance and replace the cable.
- **WARNING:** The appliance and its accessible parts become hot during use. Care should be taken to avoid touching heating elements.
- Always use oven gloves to remove or put in accessories or ovenware.

- Before carrying out any maintenance, disconnect the appliance from the power supply.
- **WARNING:** Ensure that the appliance is switched off before replacing the lamp to avoid the possibility of electric shock.
- Do not use the appliance before installing it in the built-in structure.
- Do not use a steam cleaner to clean the appliance.
- Do not use harsh abrasive cleaners or sharp metal scrapers to clean the glass door since they can scratch the surface, which may result in shattering of the glass.
- If the mains power supply cable is damaged, it must be replaced by the manufacturer, its Authorised Service Centre or similarly qualified persons to avoid an electrical hazard.
- To remove the shelf supports first pull the front of the shelf support and then the rear end away from the side walls. Install the shelf supports in the opposite sequence.
- Use only the food sensor (core temperature sensor) recommended for this appliance.

## 2. SAFETY INSTRUCTIONS

### 2.1 Installation



#### **WARNING!**

Only a qualified person must install this appliance.

- Remove all the packaging.
  - Do not install or use a damaged appliance.
  - Follow the installation instructions supplied with the appliance.
  - Always take care when moving the appliance as it is heavy. Always use safety gloves and enclosed footwear.
  - Do not pull the appliance by the handle.
  - Install the appliance in a safe and suitable place that meets installation requirements.
  - Keep the minimum distance from other appliances and units.
- Before mounting the appliance, check if the oven door opens without restraint.
  - The appliance is equipped with an electric cooling system. It must be operated with the electric power supply.
  - The built-in unit must meet the stability requirements of DIN 68930.

Cabinet minimum height (Cabinet under the worktop minimum height)	600 (600) mm
Cabinet width	550 mm
Cabinet depth	605 (580) mm
Height of the front of the appliance	594 mm

Height of the back of the appliance	576 mm
Width of the front of the appliance	549 mm
Width of the back of the appliance	548 mm
Depth of the appliance	567 mm
Built in depth of the appliance	546 mm
Depth with open door	1017 mm
Ventilation opening minimum size. Opening placed on the bottom rear side	550 x 20 mm
Mains supply cable length. Cable is placed in the right corner of the back side	1500 mm
Mounting screws	4 x 12 mm

## 2.2 Electrical connection



### WARNING!

Risk of fire and electric shock.

- All electrical connections should be made by a qualified electrician.
- The appliance must be earthed.
- Make sure that the parameters on the rating plate are compatible with the electrical ratings of the mains power supply.
- Always use a correctly installed shockproof socket.
- Do not use multi-plug adapters and extension cables.
- Make sure not to cause damage to the mains plug and to the mains cable. Should the mains cable need to be replaced, this must be carried out by our Authorised Service Centre.
- Do not let mains cables touch or come near the appliance door or the

niche below the appliance, especially when it operates or the door is hot.

- The shock protection of live and insulated parts must be fastened in such a way that it cannot be removed without tools.
- Connect the mains plug to the mains socket only at the end of the installation. Make sure that there is access to the mains plug after the installation.
- If the mains socket is loose, do not connect the mains plug.
- Do not pull the mains cable to disconnect the appliance. Always pull the mains plug.
- Use only correct isolation devices: line protecting cut-outs, fuses (screw type fuses removed from the holder), earth leakage trips and contactors.
- The electrical installation must have an isolation device which lets you disconnect the appliance from the mains at all poles. The isolation device must have a contact opening width of minimum 3 mm.
- This appliance is supplied with a main plug and a main cable.

## 2.3 Use



### WARNING!

Risk of injury, burns and electric shock or explosion.

- This appliance is for household use only.
- Do not change the specification of this appliance.
- Make sure that the ventilation openings are not blocked.
- Do not let the appliance stay unattended during operation.
- Deactivate the appliance after each use.
- Be careful when you open the appliance door while the appliance is in operation. Hot air can release.
- Do not operate the appliance with wet hands or when it has contact with water.
- Do not apply pressure on the open door.
- Do not use the appliance as a work surface or as a storage surface.

- Open the appliance door carefully. The use of ingredients with alcohol can cause a mixture of alcohol and air.
- Do not let sparks or open flames to come in contact with the appliance when you open the door.
- Do not put flammable products or items that are wet with flammable products in, near or on the appliance.

**WARNING!**

Risk of damage to the appliance.

- To prevent damage or discoloration to the enamel:
  - do not put ovenware or other objects in the appliance directly on the bottom.
  - do not put aluminium foil directly on the bottom of cavity of the appliance.
  - do not put water directly into the hot appliance.
  - do not keep moist dishes and food in the appliance after you finish the cooking.
  - be careful when you remove or install the accessories.
- Discoloration of the enamel or stainless steel has no effect on the performance of the appliance.
- Use a deep pan for moist cakes. Fruit juices cause stains that can be permanent.
- This appliance is for cooking purposes only. It must not be used for other purposes, for example room heating.
- Always cook with the oven door closed.
- If the appliance is installed behind a furniture panel (e.g. a door) make sure the door is never closed when the appliance is in operation. Heat and moisture can build up behind a closed furniture panel and cause subsequent damage to the appliance, the housing unit or the floor. Do not close the furniture panel until the appliance has cooled down completely after use.

## 2.4 Care and cleaning

**WARNING!**

Risk of injury, fire, or damage to the appliance.

- Before maintenance, deactivate the appliance and disconnect the mains plug from the mains socket.
- Make sure the appliance is cold. There is the risk that the glass panels can break.
- Replace immediately the door glass panels when they are damaged. Contact the Authorised Service Centre.
- Be careful when you remove the door from the appliance. The door is heavy!
- Clean regularly the appliance to prevent the deterioration of the surface material.
- Clean the appliance with a moist soft cloth. Use only neutral detergents. Do not use abrasive products, abrasive cleaning pads, solvents or metal objects.
- If you use an oven spray, follow the safety instruction on it's packaging.
- Do not clean the catalytic enamel (if applicable) with detergents.

## 2.5 Steam Cooking

**WARNING!**

Risk of burns and damage to the appliance.

- Released Steam can cause burns:
  - Be careful when you open the appliance door when the function is activated. Steam can release.
  - Open the appliance door with care after the steam cooking operation.

## 2.6 Internal lighting

**WARNING!**

Risk of electric shock.

- The type of light bulb or halogen lamp used for this appliance is for household appliances only. Do not use it for house lighting.
- Before replacing the lamp, disconnect the appliance from the power supply.

- Use only lamps with the same specifications.

## 2.7 Service

- To repair the appliance contact the Authorised Service Centre.
- Use original spare parts only.

## 2.8 Disposal



### WARNING!

Risk of injury or suffocation.

- Disconnect the appliance from the mains supply.
- Cut off the mains electrical cable close to the appliance and dispose of it.
- Remove the door catch to prevent children or pets from becoming trapped in the appliance.

# 3. PRODUCT DESCRIPTION

## 3.1 General overview

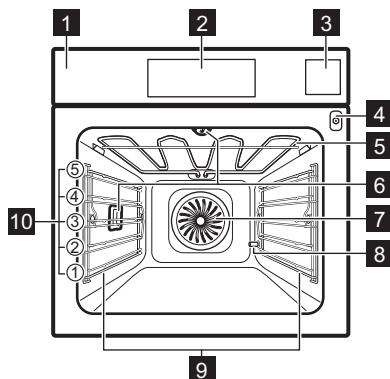

- 1 Control panel
- 2 Electronic programmer
- 3 Water drawer
- 4 Socket for the core temperature sensor
- 5 Heating element
- 6 Lamp
- 7 Fan
- 8 Descaling pipe outlet
- 9 Shelf support, removable
- 10 Shelf positions

## 3.2 Accessories

### Wire shelf

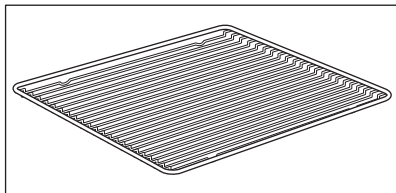

For cookware, cake tins, roasts.

### Baking tray

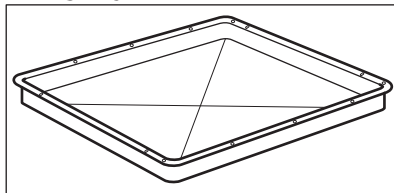

For cakes and biscuits.

### Grill- / Roasting pan

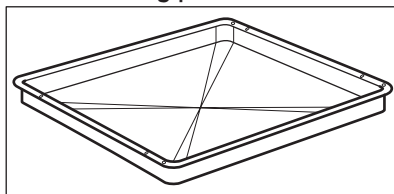

To bake and roast or as a pan to collect fat.

**Food Sensor**

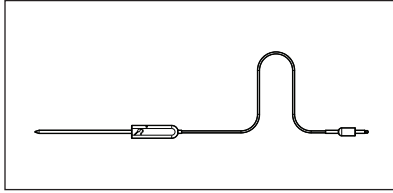

To measure the temperature inside food.

**Steam set**

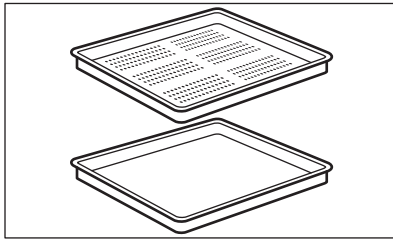

One unperforated and one perforated food container.

The steam set drains the condensing water away from the food during steam cooking. Use it to prepare vegetables, fish, chicken breast. The set is not suitable for food that needs to soak in the water e.g. rice, polenta, pasta.

## 4. CONTROL PANEL



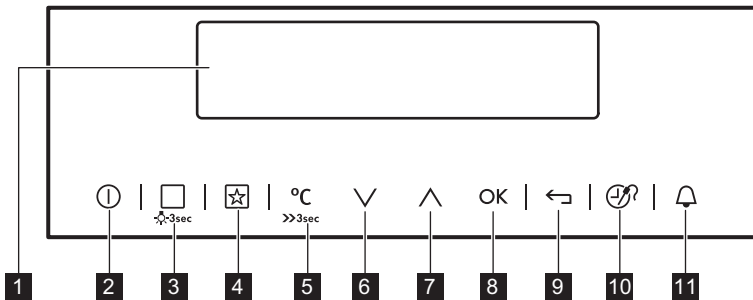





### 4.1 Electronic programmer



Use the sensor fields to operate the appliance.

Sensor field	Function	Comment
1	-	Display Shows the current settings of the oven.
2	 ON / OFF	To turn the oven on and off.







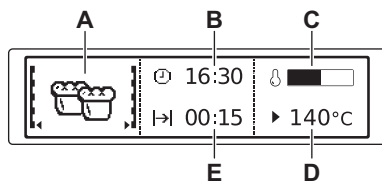







Sensor field	Function	Comment
3 	Heating Functions or Assisted Cooking	Press the sensor field once to choose a heating function or the menu: Assisted Cooking. Press the sensor field again to switch between the menus: Heating Functions, Assisted Cooking. To turn on or turn off the light, press the field for 3 seconds. You can turn on the light also when the oven is off.
4 	Favourites	To save and access your favourite programmes.
5 	Temperature selection	To set the temperature or show the current temperature in the oven. Press the field for 3 seconds to turn on or turn off the function: Fast Heat Up.
6 	Down key	To move down in the menu.
7 	Up key	To move up in the menu.
8 	OK	To confirm the selection or setting.
9 	Back key	To go back one level in the menu. To show the main menu, press the field for 3 seconds.
10 	Time and additional functions	To set different functions. When a heating function works, press the sensor field to set the timer or the functions: Function Lock, Favourites, Heat + Hold, Set + Go. You can also change the settings of the core temperature sensor.
11 	Minute Minder	To set the function: Minute Minder.

## 4.2 Display



- A. Heating function
- B. Time of day
- C. Heat-up indicator
- D. Temperature
- E. Duration time or end time of a function

Other indicators of the display:

Symbol		Function
	Minute Minder	The function works.
	Time of day	The display shows the current time.
	Duration	The display shows the necessary time for cooking.
	End Time	The display shows when the cooking time is complete.
	Temperature	The display shows the temperature.
	Time Indication	The display shows how long the heating function works. Press  and  at the same time to reset the time.
	Calculation	The oven calculates the time for cooking.
	Heat-up Indicator	The display shows the temperature in the oven.
	Fast Heat Up	The function is on. It decreases the heat up time.
	Weight Automatic	The display shows that the automatic weight system is on or that weight can be changed.
	Heat + Hold	The function is on.

## 5. BEFORE FIRST USE



### WARNING!

Refer to Safety chapters.

### 5.1 Initial Cleaning

Remove all accessories and removable shelf supports from the oven.

Refer to "Care and cleaning" chapter.

Clean the oven and the accessories before the first use.

Put the accessories and the removable shelf supports back to their initial position.

### 5.2 First Connection

When you connect the oven to the mains or after the power cut, you have to set the language, the display contrast, the display brightness and the time of the day.

1. Press  or  to set the value.
2. Press **OK** to confirm.

### 5.3 Setting the water hardness

When you connect the oven to the mains you have to set the water hardness level.





The table below shows the water hardness range (dH) with the corresponding Calcium deposit and the quality of the water.

Water hardness		Calcium deposit (mmol/l)	Calcium deposit (mg/l)	Water classification
Class	dH			
1	0 - 7	0 - 1.3	0 - 50	Soft
2	7 - 14	1.3 - 2.5	50 - 100	Moderately hard
3	14 - 21	2.5 - 3.8	100 - 150	Hard
4	over 21	over 3.8	over 150	Very hard

When the water hardness exceeds the values in the table, fill the water drawer with bottled water.

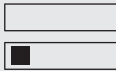
1. Take the 4 colour change strip supplied with the steam set in the oven.
2. Put all the reaction zones of the strip into the water for approximately 1 second.  
Do not put the strip into the running water.
3. Shake the strip to remove the excess of the water.
4. Wait 1 minute and check the water hardness with the table below.  
The colours of the reaction zones continue to change. Do not check the water hardness later than 1 minute after test.

5. Set the water hardness: menu: Basic Settings.

Test strip	Water hardness
	1
	2
	3
	4

You can change the water hardness in the menu: Basic Settings / Water hardness.

## 6. DAILY USE



### WARNING!

Refer to Safety chapters.

### 6.1 Navigating the menus



1. Turn on the oven.
2. Press  $\nabla$  or  $\blacktriangle$  to select the menu option.
3. Press **OK** to move to the submenu or accept the setting.







At each point you can go back to the main menu with  $\leftarrow$ .





### 6.2 The menus in overview













Main menu

Symbol / Menu item	Application
 Heating Functions	Contains a list of heating functions.
 SousVide Cooking	Contains a heating function and a list of automatic programmes.
 Recipes	Contains a list of automatic programmes.

Symbol / Menu item	Application
 Favourites	Contains a list of favourite cooking programmes created by the user.
 Cleaning	Contains a list of cleaning programmes.
 Basic Settings	Used to set the appliance configuration.
 Specials	Contains a list of additional heating functions.
 Assisted Cooking	Contains recommended oven settings for a wide choice of dishes. Select a dish and start the cooking process. The temperature and time are only guidelines for a better result and can be adjusted. They depend on the recipes and the quality and quantity of the used ingredients.

## Submenu for: Basic Settings



Symbol / Menu item	Description
 Set Time of Day	Sets the current time on the clock.
 Time Indication	When ON, the display shows the current time when you deactivate the appliance.
 Fast Heat Up	When ON, the function decreases the heat-up time.
 Set + Go	To set a function and activate it later with a press of any symbol on the control panel.

Symbol / Menu item	Description
 Heat + Hold	Keeps the prepared food warm for 30 minutes after a cooking cycle finished.
 Time Extension	Activates and deactivates the time extension function.
 Display Contrast	Adjusts the display contrast by degrees.
 Display Brightness	Adjusts the display brightness by degrees.
 Set Language	Sets the language for the display.
 Buzzer Volume	Adjusts the volume of press-tones and signals by degrees.
 Key Tones	Activates and deactivates the tone of the touch fields. It is not possible to deactivate the tone of the ON / OFF touch field.
 Alarm/Error Tones	Activates and deactivates the alarm tones.
 Water hardness	To sets the water hardness level (1 - 4).
 Cleaning Reminder	Reminds you when to clean the appliance.
 DEMO mode	Activation / deactivation code: 2468.
 Service	Shows the software version and configuration.
 Factory Settings	Resets all settings to factory settings.





## 6.3 Submenu for: SousVide Cooking

The technique comes from Sous-vide technology (French name for "under

vacuum"). It is a method of cooking in vacuum sealed plastic pouches at low temperatures.

Symbol	Menu item	Description
	SousVide Cooking	Uses the steam for cooking meat, fish, sea-food, vegetables and fruit. Set the temperature between 50 °C and 95 °C.
	SousVide Recipes	List of automatic programmes.
	Assisted SousVide	Recommended oven settings for a wide choice of dishes. Select a dish and start the cooking process. The temperature and time are only guidelines. You can adjust them for different recipes or different quantities used.





## 6.4 Submenu for: Cleaning



Symbol	Menu item	Description
	Steam Cleaning	Procedure for cleaning the appliance when it is slightly soiled and not burned several times.
	Descaling	Procedure for cleaning the steam generation circuit from residual limestone.
	Rinsing	Procedure for rinsing and cleaning the steam generation circuit after frequent use of the steam functions.
	Steam Cleaning Plus	Procedure for cleaning stubborn dirt with the support of an oven cleaner.

## 6.5 Heating Functions



Heating function	Application
 True Fan Cooking	To bake on up to three shelf positions at the same time and to dry food. Set the temperature 20 - 40 °C lower than for the function: Conventional Cooking.

Heating function	Application
 Pizza Function	To bake food on one shelf position for a more intensive browning and a crispy bottom. Set the temperature 20 - 40 °C lower than for the function: Conventional Cooking.

Heating function	Application
 Conventional Cooking	To bake and roast food on one shelf position.
 Frozen Foods	To make convenience food (e.g. french fries, potato wedges or spring rolls) crispy.
 Grill	To grill flat food and to toast bread.
 Turbo Grilling	To roast larger meat joints or poultry with bones on one shelf position. To make gratins and to brown.
 Bottom Heat	To bake cakes with crispy bottom and to preserve food.



Heating function	Application
 Moist Fan Baking	<p>This function is designed to save energy during cooking. For the cooking instructions refer to "Hints and tips" chapter, Moist Fan Baking. The oven door should be closed during cooking so that the function is not interrupted and to ensure that the oven operates with the highest energy efficiency possible. When you use this function, the temperature in the cavity may differ from the set temperature. The residual heat is used. The heating power may be reduced. For general energy saving recommendations refer to "Energy Efficiency" chapter, Energy Saving. This function was used to comply with the energy efficiency class according to EN 60350-1. When you use this function the lamp automatically turns off after 30 seconds.</p>
 Humidity Cooking	<p>You can choose between three manual cooking functions with different levels of humidity. These functions combine steam and hot air. They cover cooking with different levels of steam.</p>
 Full Steam	<p>For steaming vegetables, side dishes or fish.</p>







## Submenu for: Humidity Cooking

Heating function	Application
 Humidity Low	<p>The function is suitable for meat, poultry, oven dishes and casseroles. Thanks to the combination of steam and heat, meat gets a tender and juicy texture along with a crusty surface.</p>
 Humidity Medium	<p>The function is suitable for cooking stewed and braised meat as well as bread and sweet yeast dough. Due to the combination of steam and heat the meat gets a juicy and tender texture and yeast dough bakeries get a crispy and shiny surface.</p>
 Humidity High	<p>The function is suitable for cooking delicate dishes like custards, flans, terrines and fish.</p>

 The lamp may automatically deactivate at a temperature below 60 °C during some oven functions.

## 6.6 Specials

Heating function	Application
 Keep Warm	To keep food warm.
 Plate Warming	To preheat plates for serving.
 Preserving	To make vegetable preserves (e.g. pickles).

Heating function	Application
 Dehydrating	To dry sliced fruit, vegetables and mushrooms.
 Yogurt Function	To prepare yogurt. The lamp in this function is off.
 Dough Proving	To speed up the rising of the yeast dough. It prevents dough surface from drying and keeps the dough elastic.
 Slow Cooking	To prepare tender, succulent roasts.
 Bread Baking	Use this function to prepare bread and bread rolls with a very good professional-like result in terms of crispiness, colour and crust gloss.
 Steam Regenerating	Food reheating with steam prevents surface drying. Heat is distributed in a gentle and even way, which allows to recover taste and aroma of food as just prepared. This function can be used to reheat food directly on a plate. You can reheat more than one plate at the same time, using different shelf positions.
 Defrost	To defrost food (vegetables and fruit). The defrosting time depends on the amount and size of the frozen food.





## 6.7 Assisted Cooking

Food Category: Fish / Seafood







Dish	
Fish	Fish, baked
	Fish fingers
	Fish fillet, thin
	Fish fillet, thick
	Fish fillet, frozen
	Whole small fish
	Whole fish, steamed
	Whole small fish, grilled
	Whole fish, grilled 
	Trout
	Salmon
	Whole salmon
Prawns	Prawns, fresh
	Prawns, frozen
Mussels	-

Food Category: Poultry





Dish	
Boned poultry	-
Boned poultry 	-



Dish	
Chicken	Chicken wings, fresh
	Chicken wings, frozen
	Chicken legs, fresh
	Chicken legs, frozen
	Chicken breast, poached
	Chicken, 2 halves
	Whole chicken 
Whole duck 	-
Whole goose 	-
Whole turkey 	-

Food Category: Meat

Dish	
Beef	Prime boiled beef
	Braised meat 
	Meatloaf
Roast beef	Rare
	Rare 
	Medium
	Medium 
	Well done
	Well done 
Scandinavian beef	Rare 
	Medium 
	Well done 



Dish	
Pork	Chipolatas
	Spare ribs
	Pork knuckle, pre-cooked
	Pork joint
	Loin of pork
	Loin of pork 
	Loin of pork, smoked
	Loin of pork, poached
	Pork neck
	Pork shoulder
Veal	Roast pork 
	Cooked ham
	Veal knuckle
Lamb	Loin of veal
	Roast veal 
	Leg of lamb
	Roast lamb 
	Saddle of lamb
Lamb	Lamb joint, medium
	Lamb joint, medium 

Dish	
Game	Hare
	<ul style="list-style-type: none"> <li>• Leg of hare</li> <li>• Saddle of hare</li> <li>• Saddle of hare </li> </ul>
	Venison
	<ul style="list-style-type: none"> <li>• Haunch of venison</li> <li>• Saddle of venison</li> </ul>
	Roast game 
	Loin of game 

## Food Category: Oven Dishes

Dish	
Lasagne	-
Lasagne / Cannelloni, frozen	-
Pasta	-
Potato gratin	-
Vegetables au gratin	-
Sweet dishes	-

## Food Category: Pizza / Quiche

Dish	
Pizza	Pizza, thin
	Pizza, extra topping
	Pizza, frozen
	Pizza American, frozen
	Pizza, chilled
	Pizza snacks, frozen
Baguettes au gratin	-
Tarte flambée	-
Swiss Tarte, savoury	-

Dish	
Quiche lorraine	-
Savory flan	-

## Food Category: Cake / Pastry

Dish	
Ring cake	-
Apple cake, covered	-
Sponge cake	-
Apple pie	-
Cheese cake, tin	-
Brioche	-
Madeira cake	-
Tarte	-
Swiss Tarte, sweet	-
Almond cake	-
Muffins	-
Pastry	-
Pastry strips	-
Cream puffs	-
Puff pastry	-
Eclairs	-
Macaroons	-
Short pastry biscuits	-
Christmas stollen	-
Apple strudel, frozen	-
Cake on tray	Sponge dough Yeast dough
Cheese cake, tray	-
Brownies	-
Swiss roll	-

Dish	
Yeast cake	-
Crumble cake	-
Sugar cake	-
Flan base	Short pastry flan base Sponge mixture flan base
Fruit flan	Short pastry fruit flan Sponge mixture fruit flan Yeast dough

## Food Category: Bread / Rolls

Dish	
Rolls	Rolls Rolls, pre-baked Rolls, frozen
Ciabatta	-
Baguette	Baguette, pre-baked Baguette, frozen
Bread	Bread crown White bread Yeast plait Brown bread Rye bread Wholegrain bread Unleavened bread Bread/Rolls, frozen

## Food Category: Vegetables

Dish	
Broccoli, florets	-

Dish	
Broccoli, whole	-
Cauliflower, florets	-
Cauliflower, whole	-
Carrots	-
Courgette slices	-
Asparagus, green	-
Asparagus, white	-
Pepper strips	-
Spinach, fresh	-
Leek rings	-
Green beans	-
Mushroom slices	-
Peeling tomatoes	-
Brussels sprouts	-
Celery, cubed	-
Peas	-
Eggplant	-
Fennel	-
Artichokes	-
Beetroot	-
Black salsify	-
Cabbage turnip strips	-
White haricot beans	-
Savoy cabbage	-

Food Category: Custards / Terrines

Dish	
Egg custard	-
Flan caramel	-
Terrine	-

Dish	
Eggs	Eggs, soft boiled
	Eggs, medium boiled
	Eggs, hard boiled
	Eggs, baked

Food Category: Side dishes

Dish	
French fries, thin	-
French fries, thick	-
French fries, frozen	-
Croquettes	-
Wedges	-
Hash browns	-
Boiled potatoes, quartered	-
Boiled potatoes	-
Potatoes in their jacket	-
Potato dumplings	-
Bread dumplings	-
Yeast dumplings, salty	-
Yeast dumplings, sweet	-
Rice	-
Tagliatelle, fresh	-
Polenta	-



When it is necessary to change the weight or the core temperature of the dish, use  $\wedge$  or  $\vee$  to set the new values.

## 6.8 Submenu for: Assisted SousVide

Food category	Dish
Fish / Seafood	Sea bream fillet
	Sea bass fillet
	Cod fish
	Trout fillet
	Salmon fillet
	Scallops
	Mussels with shell
	Prawns without shell
	Octopus
Poultry	Chicken breast, boneless
	Duck breast, boneless
	Turkey breast, boneless
Meat	Beef <ul style="list-style-type: none"> <li>• Beef fillet, medium</li> <li>• Beef fillet, well done</li> </ul>
	Lamb <ul style="list-style-type: none"> <li>• Lamb, medium</li> <li>• Lamb, well done</li> </ul>
	Game <ul style="list-style-type: none"> <li>• Wild boar</li> <li>• Rabbit, boneless</li> </ul>

Food category	Dish
Vegetables	Carrots
	Courgette slices
	Asparagus, green
	Asparagus, white
	Pepper strips
	Leek rings
	Celery root
	Celery
	Eggplant
	Fennel
	Artichoke hearts
	Potatoes
	Pumpkin
Fruits	Apples
	Pears
	Peaches
	Nectarines
	Plums
	Pineapple
Mangos	

## 6.9 Setting a heating function

1. Turn on the oven.
2. Select the menu: Heating Functions.
3. Press **OK** to confirm.
4. Select a heating function.
5. Press **OK** to confirm.
6. Set the temperature.
7. Press **OK** to confirm.



In case the default settings are not changed, the oven starts automatically.

## 6.10 Water drawer

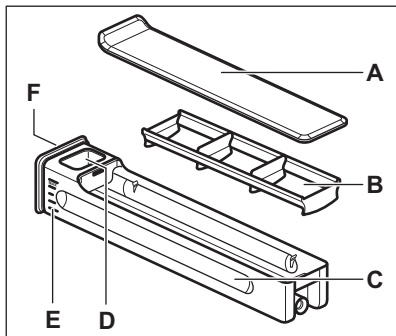

- A. Lid
- B. Wave-breaker
- C. Drawer body
- D. Water-filling hole
- E. Scale
- F. Front button

You can remove the water drawer from the oven. Push it gently on the front button. After you push the water drawer, it will self-extract from the oven.

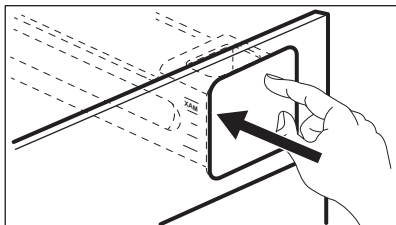

You can fill the water drawer in two ways:

- leave the water drawer inside the oven and fill it by means of a water jar,
- detach the water drawer from the oven and fill it from a water tap.

When you fill the water drawer from the water tap, carry the drawer in the horizontal position in order to avoid water spilling.

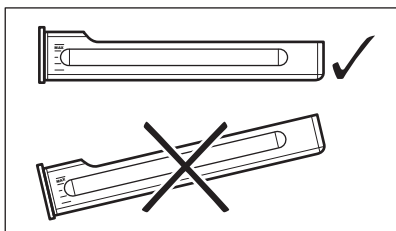

When you fill the water drawer, insert it in the same position. Push the front button until the water drawer is inside the oven.

Empty the water drawer after each use.



### CAUTION!

Keep the water drawer away from hot surfaces.

## 6.11 Steam cooking

The water drawer cover is in the control panel.



### WARNING!

Use only cold tap water. Do not use filtered (demineralised) or distilled water. Do not use other liquids. Do not put flammable or alcoholic liquids into the water drawer.

1. Press the cover of the water drawer to open it and extract it from the oven.
2. Fill the water drawer with cold water to the maximum level (around 950 ml). The water supply is sufficient for approximately 50 minutes. Use the scale on the water drawer.
3. Push the water drawer to its initial position.



Wipe the wet water drawer with a soft cloth before you insert it in the oven.

4. Turn on the oven.
5. Set a steam heating function and the temperature.
6. If necessary, set the function: Duration  $\rightarrow$  | or: End Time  $\rightarrow$  |.

The steam appears after approximately 2 minutes. When the oven reaches the set temperature, the signal sounds. When the water drawer is running out of water, the signal sounds and the water drawer needs to be refilled as described above.

The signal sounds at the end of the cooking time.

7. Turn off the oven.

8. Empty the water drawer after the steam cooking is completed.



### CAUTION!

The oven is hot. There is a risk of burns. Be careful when you empty the water drawer.

9. After Steam Cooking steam can condensate on the bottom of the cavity. Always dry the bottom of the cavity when the oven is cool.

Let the oven dry fully with the door open. To speed up the drying you can close the door and heat up the oven with the function: True Fan Cooking at temperature 150°C for approximately 15 minutes.



At the end of a steam cooking, the cooling fan runs faster to remove the steam.

## 6.12 Heat-up indicator

When you turn on a heating function, the bar on the display comes on. The bar

shows that the temperature increases. When temperature is reached the buzzer sounds 3 times and the bar flashes and then disappears.

## 6.13 Fast Heat Up

This function decreases the heat-up time.



Do not put food in the oven when the Fast heat up function works.

To turn on the function, hold  $\gg_{\text{max}}$  for 3 seconds. The heat-up indicator alternates.







This function is not available for some oven functions.

## 6.14 Residual heat

When you turn off the oven, the display shows the residual heat. You can use the heat to keep the food warm.

# 7. CLOCK FUNCTIONS

## 7.1 Clock functions table

Clock function	Application
 Minute Minder	To set a countdown (max. 2 h 30 min). This function has no effect on the operation of the oven. You can also turn it on when the oven is turned off. Use  to turn on the function. Press  or  to set the minutes and <b>OK</b> to start.
 Duration	To set how long the oven works (max. 23 h 59 min).
 End Time	To set the switch-off time for a heating function (max. 23 h 59 min).

If you set the time for a clock function, the time starts to count down after 5 seconds.



If you use the clock functions: Duration, End Time, the oven turns off the heating elements after 90 % of the set time. The oven uses the residual heat to continue the cooking process until the time ends (3 - 20 minutes).

## 7.2 Setting the clock functions



Before you use the functions: Duration, End Time, you must set a heating function and temperature first. The oven turns off automatically.

You can use the functions: Duration and End Time at the same time if you want to automatically turn on and turn off the oven on a given time later.

The functions: Duration and End Time do not work when you use the core temperature sensor.

1. Set a heating function.
2. Press again and again until the display shows the necessary clock function and the related symbol.
3. Press or to set the necessary time.
4. Press **OK** to confirm.  
When the time ends, a signal sounds. The oven turns off. The display shows a message.
5. Press any symbol to stop the signal.

### 7.3 Heat + Hold

Conditions for the function:

- The set temperature is more than 80 °C.
- The function: Duration is set.

The function: Heat + Hold keeps prepared food warm at 80 °C for 30 minutes. It turns on after the baking or roasting procedure ends.

You can turn on or turn off the function in the menu: Basic Settings.

1. Turn on the oven.
2. Select the heating function.
3. Set the temperature above 80 °C.
4. Press again and again until the display shows: Heat + Hold.
5. Press **OK** to confirm.  
When the function ends, a signal sounds.

### 7.4 Time Extension

The function: Time Extension makes the heating function continue after the end of Duration.



Not applicable to heating functions with the core temperature sensor.

1. When the cooking time ends, a signal sounds. Press any symbol. The display shows the message.
2. Press to turn on or to cancel.
3. Set the length of the function.
4. Press **OK**.

## 8. AUTOMATIC PROGRAMMES



**WARNING!**  
Refer to Safety chapters.

### 8.1 Recipes online

You can find the recipes for the automatic programmes on our website. To find the Recipe Book check the PNC number on the rating plate on the front frame of the oven cavity.

### 8.2 Recipes with Recipe Automatic

This oven has a set of recipes you can use. The recipes are fixed and you cannot change them.

1. Turn on the oven.
2. Select the menu: Recipes. Press **OK** to confirm.
3. Select the category and dish. Press **OK** to confirm.
4. Select a recipe. Press **OK** to confirm.

## 9. USING THE ACCESSORIES



**WARNING!**  
Refer to Safety chapters.

### 9.1 Food sensor

The food sensor measures temperature inside the food. When the food is at the set temperature, the appliance deactivates.

There are two temperatures to be set:

- the oven temperature (minimum 120 °C),
- the food core temperature.



**CAUTION!**  
Use only the food sensor supplied and the original replacement parts.

Directions for the best results:

- Ingredients should be at room temperature.
- Food sensor cannot be used for liquid dishes.
- During cooking the food sensor must remain in the dish and the plug in the socket.
- Use recommended food core temperature settings. Refer to "Hints and tips" chapter.



The appliance calculates an approximate end of cooking time. It depends on the quantity of food, the set oven function and temperature.

### Food categories: meat, poultry and fish

1. Activate the appliance.
2. Insert the tip of the food sensor into the centre of meat or fish, in the thickest part if possible. Make sure that at least 3/4 of the food sensor is inside of the dish.
3. Put the plug of the food sensor into the socket located in the front frame of the appliance.

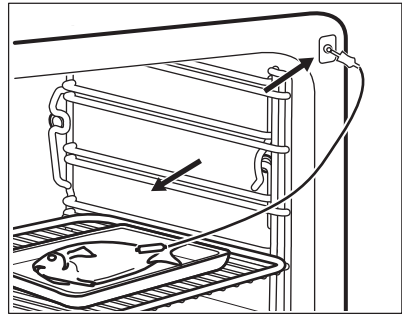
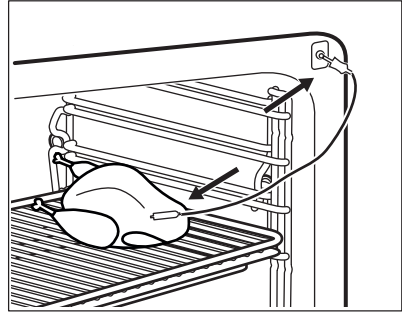

The display shows the food sensor symbol.

4. Press  $\wedge$  or  $\vee$  in less than 5 seconds to set the food core temperature.
5. Set a heating function and, if necessary, the oven temperature.
6. To change the food core temperature, press  $\text{Ⓢ}$ .

When the dish reaches the set temperature, an acoustic signal sounds. The appliance deactivates automatically.

7. Touch any symbol to stop the signal.
8. Remove the food sensor plug from the socket and remove the dish from the appliance.



**WARNING!**  
There is a risk of burns as the food sensor becomes hot. Be careful when you unplug it and remove it from the food.



## Food category: casserole

1. Activate the appliance.
2. Place half of the ingredients in a baking dish.
3. Insert the tip of the food sensor exactly in the centre of the casserole. The food sensor should be stabilized in one place during baking. Use a solid ingredient to achieve that. Use the rim of the baking dish to support the silicone handle of the food sensor. The tip of the food sensor should not touch the bottom of a baking dish.

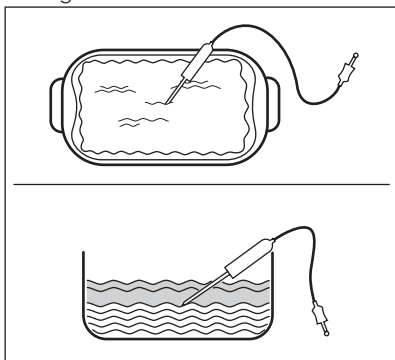

4. Cover the food sensor with the remaining ingredients.
5. Put the plug of the food sensor into the socket located in the front frame of the appliance.

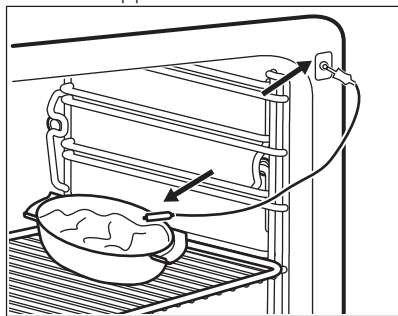

The display shows the food sensor symbol.

6. Press  $\wedge$  or  $\vee$  in less than 5 seconds to set the food core temperature.

7. Set a heating function and, if necessary, the oven temperature.
8. To change the food core temperature, press  $\text{Ⓢ}$ .

When the dish is at the set temperature, an acoustic signal sounds. The appliance deactivates automatically.

9. Touch any symbol to stop the signal.
10. Remove the food sensor plug from the socket and remove the dish from the appliance.



### WARNING!

There is a risk of burns as the food sensor becomes hot. Be careful when you unplug it and remove it from the food.

## 9.2 Inserting the accessories

Wire shelf:

Push the shelf between the guide bars of the shelf support .

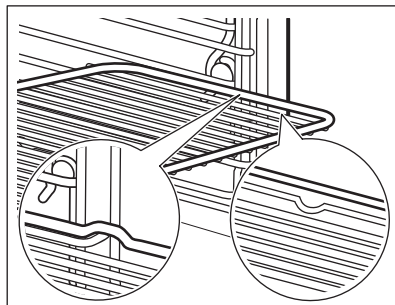

Baking tray/ Deep pan:

Push the baking tray / deep pan between the guide bars of the shelf support.

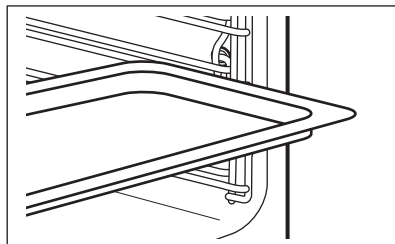

Wire shelf and baking tray / deep pan together:

Push the baking tray / deep pan between the guide bars of the shelf support and the wire shelf on the guide bars above.

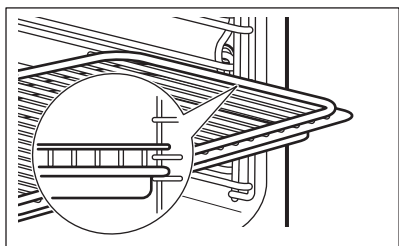

**i** Small indentation at the top increase safety. The indentations are also anti-tip devices. The high rim around the shelf prevents cookware from slipping of the shelf.

## 10. ADDITIONAL FUNCTIONS

### 10.1 Favourites

You can save your favourite settings, such as duration, temperature or heating function. They are available in the menu: Favourites. You can save 20 programmes.

#### Saving a programme

1. Turn on the oven.
2. Set a heating function or an automatic programme.
3. Press **⌂** again and again until the display shows: SAVE.
4. Press **OK** to confirm. The display shows the first free memory position.
5. Press **OK** to confirm.
6. Enter the name of the programme. The first letter flashes.
7. Press **∇** or **▲** to change the letter.
8. Press **OK**. The next letter flashes.
9. Do step 7 again as necessary.
10. Press and hold **OK** to save. You can overwrite a memory position. When the display shows the first free memory position, press **∇** or **▲** and press **OK** to overwrite an existing programme.

You can change the name of a programme in the menu: Edit Programme Name.

### Activating the programme

1. Turn on the oven.
2. Select the menu: Favourites.
3. Press **OK** to confirm.
4. Select your favourite programme name.
5. Press **OK** to confirm.

You can press **☆** to go directly to menu: Favourites. You can also use it when the oven is off.

### 10.2 Using the Child Lock



When the Child Lock is on, the oven cannot be turned on accidentally.

1. Press **⏸** to turn on the display.
2. Press **⌂** and **☆** at the same time until the display shows a message . To turn off the Child Lock function repeat step 2.

### 10.3 Function Lock

This function prevents an accidental change of the heating function. You can turn it on only when the oven works.



1. Turn on the oven.
2. Set a heating function or setting.
3. Press **⌂** again and again until the display shows: Function Lock.
4. Press **OK** to confirm.

To turn off the function, press . The display shows a message. Press  again and then **OK** to confirm.

-  When you turn off the oven, the function also turns off.

## 10.4 Set + Go

The function lets you set a heating function (or a programme) and use it later with one press of any symbol.

1. Turn on the oven.
2. Set a heating function.
3. Press  again and again until the display shows: Duration.
4. Set the time.
5. Press  again and again until the display shows: Set + Go.
6. Press **OK** to confirm.

Press any symbol (except for ) to start the function: Set + Go. The set heating function starts.

When the heating function ends, a signal sounds.

-  • Function Lock is on when the heating function works.
- The menu: Basic Settings lets you turn the function: Set + Go on and off.

## 10.5 Automatic Switch-Off

For safety reasons the oven turns off automatically after some time, if a heating function works and you do not change any settings.

 (°C)	 (h)
30 - 115	12.5
120 - 195	8.5
200 - 230	5.5

The Automatic Switch-off does not work with the functions: Light, Food Sensor, Duration, End Time.

## 10.6 Brightness of the display

There are two modes of display brightness:

- Night brightness - when the oven is turned off, the brightness of the display is lower between 10 PM and 6 AM.
- Day brightness:
  - when the oven is turned on.
  - if you touch a symbol during the night brightness (apart from ON / OFF), the display goes back to the day brightness mode for the next 10 seconds.
  - if the oven is turned off and you set the function: Minute Minder. When the function ends, the display goes back to the night brightness.

## 10.7 Cooling fan

When the oven operates, the cooling fan turns on automatically to keep the surfaces of the oven cool. If you turn off the oven, the cooling fan can continue to operate until the oven cools down.

# 11. HINTS AND TIPS

 **WARNING!**  
Refer to Safety chapters.

-  The temperature and baking times in the tables are guidelines only. They depend on the recipes and the quality and quantity of the ingredients used.

## 11.1 Cooking recommendations

Your oven may bake or roast differently to the oven you had before. The tables below show recommended settings for temperature, cooking time and shelf position for specific types of the food.

If you cannot find the settings for a special recipe, look for the similar one.

## 11.2 Inner side of the door

**On the inner side of the door you can find:**

- the numbers of the shelf positions.
- information about the heating functions, recommended shelf positions and temperatures for dishes.

## 11.3 Advice for special heating functions of the oven

### Keep Warm

The function allows you to keep food warm. The temperature is set automatically to 80 °C.

### Plate Warming

The function allows you to warm plates and dishes before serving. The temperature is set automatically to 70 °C.

Place plates and dishes in stacks evenly on the wire shelf. Use the first shelf position. After half of the warming time switch their places.

### Dough Proving

The function allows you to rise yeast dough. Put the dough into a big dish. Use the first shelf position. Set function: Dough Proving and the cooking time.

### Defrost

Remove the food packaging and put the food on a plate. Do not cover the food, as it can extend the defrosting time. Use the first shelf position.

## 11.4 SousVide Cooking

This function uses lower cooking temperatures than normal cooking.

### SousVide Cooking Recommendations

Use high quality and fresh raw food. Always clean the food before cooking. Be careful when using raw eggs.

Low temperatures are suitable only for the types of food that can be eaten raw.

Do not cook the food for a long time when you are using the temperature below 60 °C.

Boil ingredients containing alcohol before vacuum packing.

Put the vacuum bags on the grid side by side.

You can keep the cooked food in the fridge for 2 – 3 days. Cool down the food quickly (by using ice bath).

Do not use this function for reheating food leftovers.

### Vacuum Packing

Use only the vacuum bags and chamber vacuum sealer recommended for sous-vide cooking. Only this type of vacuum sealer can vacuum pack liquids.

Do not reuse vacuum bags.

For faster and better results set the maximum vacuum degree.

To guarantee a safe closing of the vacuum bag, make sure that the area subject to the seal is clean.





Make sure that the edges of the inner side of the vacuum bag are clean, before sealing it.





## 11.5 SousVide Cooking: Meat





Use only boneless meat to avoid piercing the vacuum bags.

Fry the poultry fillets skin side down before vacuum packing.

Use the third shelf position.

 <b>BEEF</b>		
 <b>Beef / Veal fillet</b>	 <b>(°C)</b>	 <b>(min)</b>
Medium, 4 cm thick, 0.8 kg	60	110 - 120
Well done, 4 cm thick, 0.8 kg	65	90 - 100

 <b>LAMB / GAME</b>		
	 <b>(°C)</b>	 <b>(min)</b>
Lamb rare, 3 cm thick, 0.6 - 0.65 kg	60	180 - 190
Lamb medium, 3 cm thick, 0.6 - 0.65 kg	65	105 - 115
Boar, 3 cm thick, 0.6 - 0.65 kg	90	60 - 70
Rabbit, 1.5 cm thick, 0.6 - 0.65 kg	70	50 - 60





 <b>POULTRY</b>		
	 <b>(°C)</b>	 <b>(min)</b>
Chicken breast, 3 cm thick, 0.75 kg	70	70 - 80
Duck breast, 2 cm thick, 0.9 kg	60	140 - 160
Turkey breast, 2 cm thick, 0.8 kg	70	75 - 85

## 11.6 SousVide Cooking: Fish and seafood

Dry the fish fillets with a paper towel before you put them in a vacuum bag.

Add a cup of water in the vacuum bag when you cook the mussels.

Use the third shelf position.





 <b>FISH AND SEAFOOD</b>		
	 <b>(°C)</b>	 <b>(min)</b>
Sea bream, 4 fillets 1cm thick, 0.5 kg	70	25
Sea bass, 4 fillets 1cm thick, 0.5 kg	70	25
Cod fish, 2 fillets 2 cm thick, 0.65 kg	65	70 - 75
Scallops, 0.65 kg	60	100 - 110
Mussels with shell, 1 kg	95	20 - 25
Prawns without shell, 0.5 kg	75	25 - 30
Octopus, 1 kg	85	100 - 110
Trout, 2 fillets 1.5 cm thick, 0.65 kg	65	55 - 65
Salmon, fillet 3 cm thick, 0.8 kg	65	100 - 110





To prevent protein leak soak the trout or salmon in a 10 % salt solution (100 g salt in 1 litre of water) for 30 min and dry with a paper towel before you put it in a vacuum bag.

## 11.7 SousVide Cooking: Vegetables

To keep the colour of the artichokes, put them in water with lemon juice, after you clean and cut them.

Use the third shelf position.





 <b>VEGETABLES</b>	
 <b>Set the temperature to 90 °C.</b>	
	 (min)
Asparagus green, whole, 0.7 - 0.8 kg	40 - 50
Asparagus white, whole, 0.7 - 0.8 kg	50 - 60
Courgette, slices of 1 cm, 0.7 - 0.8 kg	35 - 40
Eggplant, slices of 1 cm, 0.7 - 0.8 kg	30 - 35
Pumpkin, pieces, 2 cm thick, 0.7 - 0.8 kg	25 - 30

 <b>VEGETABLES</b>	
 <b>Set the temperature to 95 °C.</b>	
	 (min)
Leek, stripes or rings, 0.6 - 0.7 kg	40 - 45
Peppers, stripes or quarter, 0.7 - 0.8 kg	35 - 40
Celery, rings of 1 cm, 0.7 - 0.8 kg	40 - 45
Carrots, slices of 0.5 cm, 0.7 - 0.8 kg	35 - 45
Celery root, slices of 1 cm, 0.7 - 0.8 kg	45 - 50
Fennel, slices of 1 cm, 0.7 - 0.8 kg	35 - 45
Potatoes, slices of 1 cm, 0.8 - 1 kg	35 - 45
Artichoke hearts, quarter, 0.4 - 0.6 kg	45 - 55

## 11.8 SousVide Cooking: Fruit and sweets

To keep the colour of the apples and pears, put them in water with lemon juice, after you clean and cut them.

Use the third shelf position.

 <b>FRUIT</b>		
	 (°C)	 (min)
Peaches, 4, halves	90	20 - 25
Plums, halves, 0.6 kg	90	10 - 15
Mangos, 2, cut in cubes 2 cm thick	90	10 - 15
Pears, 4, halves	90	15 - 30
Nectarines, 4, halves	90	20 - 25
Pineapples, slices 1 cm, 0.6 kg	90	20 - 25
Apples, 4, quarter	95	25 - 30
Vanilla creme x2, 350 g in each bag	85	20 - 22

## 11.9 Steam cooking

Use only heat and corrosion resistant or chrome steel cookware.

When you cook on more than one level make sure that there is a distance between the shelves to let the steam circulate.

Start cooking with a cold oven unless the preheating is recommended in the below table.

## 11.10 Full Steam

Be careful when you open the oven door when the function is on. Steam can release.

### Sterilisation

This function allows you to sterilise containers (e.g. baby bottles).

Put the clean containers upside down in the centre of the shelf on the first shelf position.

Fill the drawer to the maximum level and set the time to 40 minutes.

### Cooking

This function allows you to prepare all types of food, fresh or frozen. You can use it to cook, warm, defrost, poach or blanch vegetables, meat, fish, pasta, rice, semolina and eggs.

You can prepare a meal comprising a few dishes during a single cooking session. To ensure all the dishes will be ready at the same time start with the food with the longest cooking time then add the remaining dishes at the appropriate time, as specified in the cooking tables

**Example: The total time of this cooking session is 40 min. First, put in Boiled potatoes, quartered, after 20 min add Salmon fillets and Broccoli, florets after 30 min.**



(min)

Boiled potatoes,  
quartered

40

Salmon fillets

20

Broccoli, florets

10

Use the largest quantity of water required when you cook more than one dish at the same time.

Use the second shelf position.



### VEGETABLES



Set the temperature to 99 °C.



(min)



8 - 10

Broccoli, florets, preheat  
the empty oven

10

Peeled tomatoes

10 - 15

Spinach, fresh

10 - 15

Courgette, slices

15

Vegetables, blanched

15 - 20

Mushroom, slices

15 - 20

Pepper, strips

15 - 25

Broccoli, whole

15 - 25

Asparagus, green

15 - 25

Aubergines

15 - 25

Pumpkin, cubes

15 - 25

Tomatoes

20 - 25

Beans, blanched

20 - 25

Lamb's lettuce, florets

20 - 25

Savoy cabbage

20 - 30

Celery, cubed

20 - 30

Leek, rings

20 - 30

Peas

20 - 30

Snow peas / Kaiser peppers

20 - 30

Sweet potatoes

20 - 30

Fennel

20 - 30





Carrots





25 - 35





Asparagus, white

25 - 35





Brussels sprouts





 <b>VEGETABLES</b>	
 <b>Set the temperature to 99 °C.</b>	
 (min)	
25 - 35	Cauliflower, florets
25 - 35	Kohlrabi, strips
25 - 35	White haricot beans
30 - 40	Sweet corn on the cob
35 - 45	Black salsify
35 - 45	Cauliflower, whole
35 - 45	Green beans
40 - 45	Cabbage white or red, strips
50 - 60	Artichokes
55 - 65	Dried beans, soaked, water / beans ratio 2:1
60 - 90	Sauerkraut
70 - 90	Beetroot





 <b>SIDE DISHES / ACCOMPANIMENTS</b>	
 <b>Set the temperature to 99 °C.</b>	
 (min)	
15 - 20	Couscous, water / couscous ratio 1:1
15 - 25	Tagliatelle, fresh
20 - 25	Semolina pudding, milk / semolina ratio 3.5:1





 <b>SIDE DISHES / ACCOMPANIMENTS</b>	
 <b>Set the temperature to 99 °C.</b>	
 (min)	
20 - 30	Lentils, red, water / lentils ratio 1:1
25 - 30	Spaetzle
25 - 35	Bulgur, water / bulgur ratio 1:1
25 - 35	Yeast dumplings
30 - 35	Fragrant rice, water / rice ratio 1:1
30 - 40	Boiled potatoes, quartered
35 - 45	Bread dumpling
35 - 45	Potato dumplings
35 - 45	Rice, water / rice ratio 1:1, the ratio of water to rice can change according to the type of rice
40 - 50	Polenta, liquid ratio 3:1
40 - 55	Rice pudding, milk / rice ratio 2.5:1
45 - 55	Unpeeled potatoes, medium
55 - 60	Lentils, brown and green, water / lentils ratio 2:1







 <b>FRUIT</b>		
 <b>Set the temperature to 99 °C.</b>		
 (min)		
10 - 15	Apple slices	
10 - 15	Hot berries	
10 - 20	Chocolate melting	
20 - 25	Fruit compote	

 <b>FISH</b>		
 (min)		 (°C)
15 - 20	Thin fish fillet	75 - 80
20 - 25	Prawns, fresh	75 - 85
20 - 30	Mussels	100
20 - 30	Salmon fillets	85
20 - 30	Trout, 0.25 kg	85
30 - 40	Prawns, frozen	75 - 85
40 - 45	Salmon trout, 1 kg	85

 <b>MEAT</b>		
 (min)		 (°C)
15 - 20	Chipolatas	80
20 - 30	Bavarian veal sausage / White sausage	80
20 - 30	Vienna sausage	80

 <b>MEAT</b>		
 (min)		 (°C)
25 - 35	Chicken breast, poached	90
55 - 65	Cooked ham, 1 kg	99
60 - 70	Chicken, poached, 1 - 1.2 kg	99
70 - 90	Kasseler, poached	90
80 - 90	Veal / Pork loin, 0.8 - 1 kg	90
110 - 120	Tafelspitz	99

 <b>EGGS</b>		
 <b>Set the temperature to 99 °C.</b>		
 (min)		
10 - 11	Eggs, soft-boiled	
12 - 13	Eggs, medium-boiled	
18 - 21	Eggs, hard-boiled	

### 11.11 Combining function: Turbo Grilling + Full Steam







You can combine these functions to cook meat, vegetables and side dishes at one time.

1. Set the function: Turbo Grilling to roast meat.
2. Add the prepared vegetables and side dishes.
3. Decrease oven temperature to around 90 °C. You can open the oven





door to the first position for approximately 15 minutes.

4. Set the function: Full Steam. Cook all dishes together until they are ready.

Use the first shelf position for meat and the third shelf position for vegetables.





	 <b>Turbo Grilling</b> First step: cook meat		 <b>Full Steam</b> Second step: add vegetables	
	 (°C)	 (min)	 (°C)	 (min)
Roast beef, 1 kg / Brussels sprouts, polenta	180	60 - 70	99	40 - 50
Roast pork, 1 kg / Potatoes / Vegetables, gravy	180	60 - 70	99	30 - 40
Roast veal, 1 kg / Rice / Vegetables	180	50 - 60	99	30 - 40

## 11.12 Humidity High

 Use the second shelf position.		
	 (°C)	 (min)
Thin fish fillet	85	15 - 25
Baked eggs	90 - 110	15 - 30
Small fish, up to 0.35 kg	90	20 - 30
Thick fish fillet	90	25 - 35
Whole fish, up to 1 kg	90	30 - 40
Custard, flan in small dishes	90	35 - 45
Terrine	90	40 - 50
Dumplings	120 - 130	40 - 50



## 11.13 Humidity Medium



 Use the second shelf position.		
	 (°C)	 (min)
Sweet yeast dough bakeries	170 - 180	20 - 35
Bread rolls	180 - 200	25 - 35
Roasted fish fillet	170 - 180	25 - 40
Sweet bread	160 - 170	30 - 45
Roasted fish	170 - 180	35 - 45
Sweet oven dishes	160 - 180	45 - 60
Various types of bread, 0.5 - 1 kg	180 - 190	45 - 60
Spare rib	140 - 150	75 - 100

 Use the second shelf position.		
	 (°C)	 (min)
Stewed / Braised meat	140 - 150	100 - 140

### 11.14 Humidity Low



Use the second shelf position unless specified otherwise.

	 (°C)	 (min)
Ready-to-bake rolls	200	15 - 20
Ready-to-bake baguettes, 40 - 50 g	200	15 - 20
Bread rolls, 40 - 60 g	180 - 200	25 - 35
Ready-to-bake baguettes, frozen, 40 - 50 g	200	25 - 35
Meatloaf, raw, 0.5 kg	180	30 - 40
Pasta bake	170 - 190	40 - 50
Lasagne	170 - 180	45 - 55
Bread, 0.5 - 1 kg	180 - 190	45 - 60
Potato gratin	160 - 170	50 - 60
Chicken, 1 kg	180 - 210	50 - 60
Pork loin, smoked, 0.6 - 1 kg, soak for 2 hours	160 - 180	60 - 70
Roast beef, 1 kg	180 - 200	60 - 90
Duck, 1.5 - 2 kg	180	70 - 90

	 (°C)	 (min)
Roast veal, 1 kg	180	80 - 90
Roast pork, 1 kg	160 - 180	90 - 100
Goose, 3 kg, use the first shelf position	170	130 - 170

### 11.15 Steam Regenerating

Use the second shelf position.



	 (°C)	 (min)
One-plate dishes	110	10 - 15
Pasta	110	10 - 15
Rice	110	10 - 15
Dumplings	110	15 - 25

### 11.16 Yogurt Function

This function allows you to prepare yogurt.

Mix 0.25 kg of yogurt with 1 l of milk. Fill it in yogurt jars.

If you use raw milk, boil it first and let it cool down to 40 °C.

 Use the second shelf position.	
	 (h)
Yogurt, creamy	5 - 6
Yogurt, thick	7 - 8

### 11.17 Baking

Use the lower temperature the first time.

You can extend baking times by 10 - 15 minutes if you bake cakes on more than one shelf position.







Cakes and pastries at different heights do not always brown equally. There is no need to change the temperature setting if an unequal browning occurs. The differences equalize during baking.







Trays in the oven can twist during baking. When the trays become cold again, the distortions disappear.







## 11.18 Tips on baking







Baking results	Possible cause	Remedy
The bottom of the cake is not baked sufficiently.	The shelf position is incorrect.	Put the cake on a lower shelf.
The cake sinks and becomes soggy or streaky.	The oven temperature is too high.	Next time set slightly lower oven temperature.
	The baking time is too short.	Next time set a longer baking time and lower oven temperature.
The cake is too dry.	The oven temperature is too low.	Next time set higher oven temperature.
	The baking time is too long.	Next time set shorter baking time.
The cake bakes unevenly.	The oven temperature is too high and the baking time is too short.	Set lower oven temperature and longer baking time.
	The cake batter is not evenly distributed.	Next time spread the cake batter evenly on the baking tray.
The cake is not ready in the baking time specified in a recipe.	The oven temperature is too low.	Next time set a slightly higher oven temperature.

## 11.19 Baking on one level





 <b>BAKING IN TINS</b>				
		 (°C)	 (min)	
Ring cake / Brioche	True Fan Cooking	150 - 160	50 - 70	1
Madeira cake / Fruit cakes	True Fan Cooking	140 - 160	70 - 90	1
Flan base - short pastry, preheat the empty oven	True Fan Cooking	150 - 160	20 - 30	2
Flan base - sponge cake mixture	True Fan Cooking	150 - 170	20 - 25	2

 <b>BAKING IN TINS</b>				
		 (°C)	 (min)	
Cheesecake	Conventional Cooking	170 - 190	60 - 90	1

 <b>CAKES / PASTRIES / BREADS ON BAKING TRAYS</b>				
 <b>Preheat the empty oven unless specified otherwise.</b>				
		 (°C)	 (min)	
Plaited bread / Bread crown, pre-heating is not needed	Conventional Cooking	170 - 190	30 - 40	3
Christstollen	Conventional Cooking	160 - 180	50 - 70	2
Rye bread:	Conventional Cooking	first: 230 then: 160 - 180	20 30 - 60	1
Cream puffs / Eclairs	Conventional Cooking	190 - 210	20 - 35	3
Swiss roll,	Conventional Cooking	180 - 200	10 - 20	3
Cake with crumble topping, pre-heating is not needed	True Fan Cooking	150 - 160	20 - 40	3
Buttered almond cake / Sugar cakes	Conventional Cooking	190 - 210	20 - 30	3
Fruit flans, pre-heating is not needed	Conventional Cooking	180	35 - 55	3
Yeast cakes with delicate toppings (e.g. quark, cream, custard)	Conventional Cooking	160 - 180	40 - 60	3

 <b>BISCUITS</b>			
 <b>Use the third shelf position.</b>			
		 (°C)	 (min)
Short pastry / Sponge cake mixture	True Fan Cooking	150 - 160	15 - 25
Meringues	True Fan Cooking	80 - 100	120 - 150
Macaroons	True Fan Cooking	100 - 120	30 - 50
Yeast dough biscuits	True Fan Cooking	150 - 160	20 - 40
Puff pastries, preheat the empty oven	True Fan Cooking	170 - 180	20 - 30
Rolls, preheat the empty oven	Conventional Cooking	190 - 210	10 - 25





## 11.20 Bakes and gratins





 <b>Use the first shelf position.</b>			
		 (°C)	 (min)
Pasta bake	Conventional Cooking	180 - 200	45 - 60
Lasagne	Conventional Cooking	180 - 200	25 - 40
Vegetables au gratin, preheat the empty oven	Turbo Grilling	170 - 190	15 - 35
Baguettes with melted cheese	True Fan Cooking	160 - 170	15 - 30
Milk rice	Conventional Cooking	180 - 200	40 - 60
Fish bakes	Conventional Cooking	180 - 200	30 - 60
Stuffed vegetables	True Fan Cooking	160 - 170	30 - 60





## 11.21 Multilevel Baking

Use the function: True Fan Cooking.

For 2 trays use the first and fourth shelf position.

 <b>CAKES / PASTRIES / BREADS ON BAKING TRAYS</b>		
	 (°C)	 (min)
Cream puffs / Eclairs, preheat the empty oven	160 - 180	25 - 45
Dry streusel cake	150 - 160	30 - 45

 <b>BISCUITS</b>		
	 (°C)	 (min)
Short pastry biscuits	150 - 160	20 - 40
Meringues	80 - 100	130 - 170
Macaroons	100 - 120	40 - 80
Yeast dough biscuits	160 - 170	30 - 60

 <b>BISCUITS</b>		
	 (°C)	 (min)
Puff pastries, preheat the empty oven	170 - 180	30 - 50
Rolls	180	20 - 30

## 11.22 Tips on Roasting

Use heat-resistant ovenware.

Roast lean meat covered.

Roast large meat joints directly in the tray or on the wire shelf placed above the tray.

Put some water in the tray to prevent dripping fat from burning.







Turn the roast after 1/2 - 2/3 of the cooking time.







Roast meat and fish in large pieces (1 kg or more).







Baste meat joints with their own juice several times during roasting.







## 11.23 Roasting

Use the first shelf position.







 <b>BEEF</b>				
			 (°C)	 (min)
Pot roast	1 - 1.5 kg	Conventional Cooking	230	120 - 150
Roast beef or fillet, rare, preheat the empty oven	1 cm thick	Turbo Grilling	190 - 200	5 - 6
Roast beef or fillet, medium, preheat the empty oven	1 cm thick	Turbo Grilling	180 - 190	6 - 8

 BEEF				
			 (°C)	 (min)
Roast beef or fillet, well done, preheat the empty oven	1 cm thick	Turbo Grilling	170 - 180	8 - 10







 PORK				
 Use the function: Turbo Grilling.				
	 (kg)	 (°C)	 (min)	
Shoulder / Neck / Ham joint	1 - 1.5	150 - 170	90 - 120	
Chops / Spare rib	1 - 1.5	170 - 190	30 - 60	
Meatloaf	0.75 - 1	160 - 170	50 - 60	
Pork knuckle, precooked	0.75 - 1	150 - 170	90 - 120	

 VEAL				
 Use the function: Turbo Grilling.				
	 (kg)	 (°C)	 (min)	
Roast veal	1	160 - 180	90 - 120	
Veal knuckle	1.5 - 2	160 - 180	120 - 150	















 LAMB				
 Use the function: Turbo Grilling.				
	 (kg)	 (°C)	 (min)	
Lamb leg / Roast lamb	1 - 1.5	150 - 170	100 - 120	
Lamb saddle	1 - 1.5	160 - 180	40 - 60	







  

 GAME				
	 (kg)		 (°C)	 (min)
Saddle / Hare leg, preheat the empty oven	1	Turbo Grilling	180 - 200	35 - 55
Venison saddle	1.5 - 2	Conventional Cooking	180 - 200	60 - 90
Haunch of venison	1.5 - 2	Conventional Cooking	180 - 200	60 - 90

 POULTRY				
 Use the function: Turbo Grilling.				
	 (kg)	 (°C)	 (min)	
Poultry, portions	0.2 - 0.25	200 - 220	30 - 50	
Chicken, half	0.4 - 0.5	190 - 210	40 - 50	
Chicken, poulard	1 - 1.5	190 - 210	50 - 70	
Duck	1.5 - 2	180 - 200	80 - 100	
Goose	3.5 - 5	160 - 180	120 - 180	





 POULTRY			
 Use the function: Turbo Grilling.			
	 (kg)	 (°C)	 (min)
Turkey	2.5 - 3.5	160 - 180	120 - 150
Turkey	4 - 6	140 - 160	150 - 240

 FISH				
	 (kg)		 (°C)	 (min)
Whole fish	1 - 1.5	Turbo Grilling	180 - 200	30 - 50





## 11.24 Bread Baking

Use the second shelf position.







Preheating is not recommended.

 BREAD		
	 (°C)	 (min)
White bread	170 - 190	40 - 60
Baguette	200 - 220	35 - 45
Brioche	180 - 200	40 - 60
Ciabatta	200 - 220	35 - 45
Rye bread	170 - 190	50 - 70
Wholemeal bread	170 - 190	50 - 70
Whole grain bread	170 - 190	40 - 60
Bread rolls	190 - 210	20 - 35

## 11.25 Crispy baking with Pizza Function

 PIZZA		
 Use the first shelf position.		
	 (°C)	 (min)
Tarts	180 - 200	40 - 55
Spinach flan	160 - 180	45 - 60
Quiche lorraine / Swiss flan	170 - 190	45 - 55
Apple pie, covered	150 - 170	50 - 60







  

 PIZZA		
 Preheat the empty oven before cooking.		
 Use the second shelf position.		
	 (°C)	 (min)
Pizza, thin crust, use the deep pan	210 - 230	15 - 25
Pizza, thick crust	180 - 200	20 - 30
Unleavened bread	210 - 230	10 - 20
Puff pastry flan	160 - 180	45 - 55
Flammkuchen	210 - 230	15 - 25
Pierogi	180 - 200	15 - 25
Vegetable pie	160 - 180	50 - 60

## 11.26 Grill

Preheat the empty oven before cooking.

Put the pan into the first shelf position to collect fat.

 GRILL				
	 (°C)	 (min) 1st side	 (min) 2nd side	
Roast beef	210 - 230	30 - 40	30 - 40	2
Beef fillet	230	20 - 30	20 - 30	3
Pork loin	210 - 230	30 - 40	30 - 40	2
Veal loin	210 - 230	30 - 40	30 - 40	2
Lamb saddle	210 - 230	25 - 35	20 - 25	3
Whole fish, 0.5 - 1 kg	210 - 230	15 - 30	15 - 30	3 / 4





## 11.27 Slow Cooking

This function allows you to prepare lean, tender meat and fish. It is not applicable for: poultry, fatty roast pork, pot roast.





Food Sensor temperature should not be higher than 65 °C .

1. Sear the meat for 1 - 2 minutes on each side in a pan over high heat.
2. Put the meat in the roasting pan or directly on the wire shelf. Put a tray below the wire shelf to collect fat.
3. Use Food Sensor.
4. Select the function: Slow Cooking. You can set the temperature between 80 °C and 150 °C for the first 10 minutes. The default is 90 °C. Set the temperature for Food Sensor.
5. After 10 minutes, the oven automatically lowers the temperature to 80 °C.

Always cook without a lid while using this function.

 Set the temperature to 120 °C.			
	 (kg)	 (min)	
Steaks	0.2 - 0.3	20 - 40	3
Fillet of beef	1 - 1.5	90 - 150	3
Roast beef	1 - 1.5	120 - 150	1
Roast veal	1 - 1.5	120 - 150	1

## 11.28 Frozen Foods

 DEFROSTING			
	 (°C)	 (min)	
Pizza, frozen	200 - 220	15 - 25	2
Pizza American, frozen	190 - 210	20 - 25	2
Pizza, chilled	210 - 230	13 - 25	2
Pizza snacks, frozen	180 - 200	15 - 30	2
French fries, thin	190 - 210	15 - 25	3
French fries, thick	190 - 210	20 - 30	3
Wedges / Croquettes	190 - 210	20 - 40	3
Hash browns	210 - 230	20 - 30	3
Lasagne / Cannelloni, fresh	170 - 190	35 - 45	2
Lasagne / Cannelloni, frozen	160 - 180	40 - 60	2
Baked cheese	170 - 190	20 - 30	3
Chicken wings	180 - 200	40 - 50	2

## 11.29 Preserving

Use only preserve jars of the same dimensions available on the market.

Do not use jars with twist-off and bayonet type lids or metal tins.

Use the first shelf position.

Put no more than six one-litre preserve jars on the baking tray.



Fill the jars equally and close with a clamp.





The jars cannot touch each other.





Put approximately 1/2 litre of water into the baking tray to give sufficient moisture in the oven.

When the liquid in the jars starts to simmer (after approximately 35 - 60 minutes with one-litre jars), stop the oven or decrease the temperature to 100 °C (see the table).

Set the temperature to 160 - 170 °C.

 SOFT FRUIT	
	 (min) <b>Cooking time until simmering</b>
Strawberries / Blueberries / Raspberries / Ripe gooseberries	35 - 45



 <b>STONE FRUIT</b>		
	 (min) <b>Cooking time until simmering</b>	 (min) <b>Continue to cook at 100 °C</b>
Peaches / Quinces / Plums	35 - 45	10 - 15

 <b>VEGETABLES</b>		
	 (min) <b>Cooking time until simmering</b>	 (min) <b>Continue to cook at 100 °C</b>
Carrots	50 - 60	5 - 10
Cucumbers	50 - 60	-
Mixed pickles	50 - 60	5 - 10
Kohlrabi / Peas / Aspar- agus	50 - 60	15 - 20

### 11.30 Dehydrating - True Fan Cooking

Cover trays with grease proof paper or baking parchment.





### 11.31 Food Sensor

 <b>BEEF</b>	 <b>Food core temperature (°C)</b>		
	<b>Rare</b>	<b>Medium</b>	<b>Well done</b>
Roast beef	45	60	70
Sirloin	45	60	70



For a better result, stop the oven halfway through the drying time, open the door and let it cool down for one night to complete the drying.



For 1 tray use the third shelf position.

For 2 trays use the first and fourth shelf position.



 <b>VEGETABLES</b>		
	 (°C)	 (h)
Beans	60 - 70	6 - 8
Peppers	60 - 70	5 - 6
Vegetables for soup	60 - 70	5 - 6
Mushrooms	50 - 60	6 - 8
Herbs	40 - 50	2 - 3

Set the temperature to 60 - 70 °C.



 <b>FRUIT</b>	
	 (h)
Plums	8 - 10
Apricots	8 - 10
Apple slices	6 - 8
Pears	6 - 9

 <b>BEEF</b>	 Food core temperature (°C)		
	<b>Less</b>	<b>Medium</b>	<b>More</b>
Meatloaf	80	83	86



  

 <b>PORK</b>	 Food core temperature (°C)		
	<b>Less</b>	<b>Medium</b>	<b>More</b>
Ham / Roast	80	84	88
Saddle chop / Pork loin, smoked / Pork loin, poached	75	78	82



  



 <b>VEAL</b>	 Food core temperature (°C)		
	<b>Less</b>	<b>Medium</b>	<b>More</b>
Roast veal	75	80	85
Veal knuckle	85	88	90



  



 <b>MUTTON / LAMB</b>	 Food core temperature (°C)		
	<b>Less</b>	<b>Medium</b>	<b>More</b>
Mutton leg	80	85	88
Mutton saddle	75	80	85
Roast lamb / Lamb leg	65	70	75



  



 <b>GAME</b>	 Food core temperature (°C)		
	<b>Less</b>	<b>Medium</b>	<b>More</b>
Hare saddle / Venison saddle	65	70	75
Hare leg / Hare, whole / Venison leg	70	75	80

 <b>POULTRY</b>	 <b>Food core temperature (°C)</b>		
	<b>Less</b>	<b>Medium</b>	<b>More</b>
Chicken	80	83	86
Duck, whole / half / Turkey, whole / breast	75	80	85
Duck, breast	60	65	70

 <b>FISH (SALMON, TROUT, ZANDER)</b>	 <b>Food core temperature (°C)</b>		
	<b>Less</b>	<b>Medium</b>	<b>More</b>
Fish, whole / large / steamed / Fish, whole / large / roasted	60	64	68

 <b>CASSEROLES - PRE-COOKED VEGETABLES</b>	 <b>Food core temperature (°C)</b>		
	<b>Less</b>	<b>Medium</b>	<b>More</b>
Zucchini casserole / Broccoli casserole / Fennel casserole	85	88	91

 <b>CASSEROLES - SAVOURY</b>	 <b>Food core temperature (°C)</b>		
	<b>Less</b>	<b>Medium</b>	<b>More</b>
Cannelloni / Lasagne / Pasta bake	85	88	91



 <b>CASSEROLES - SWEET</b>	 <b>Food core temperature (°C)</b>		
	<b>Less</b>	<b>Medium</b>	<b>More</b>
White bread casserole with / without fruit / Rice porridge casserole with / without fruit / Sweet noodle casserole	80	85	90

### 11.32 Moist Fan Baking - recommended accessories

Use the dark and non-reflective tins and containers. They have better heat

absorption than the light colour and reflective dishes.

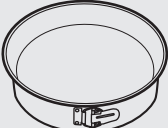



			
<b>Pizza pan</b>	<b>Baking dish</b>	<b>Ramekins</b>	<b>Flan base tin</b>
Dark, non-reflective 28 cm diameter	Dark, non-reflective 26 cm diameter	Ceramic 8 cm diameter, 5 cm height	Dark, non-reflective 28 cm diameter

### 11.33 Moist Fan Baking







For the best results follow suggestions listed in the table below.







Use the third shelf position.







	 (°C)	 (min)
Pasta gratin	200 - 220	45 - 55
Potato gratin	180 - 200	70 - 85
Moussaka	170 - 190	70 - 95
Lasagne	180 - 200	75 - 90
Cannelloni	180 - 200	70 - 85
Bread pudding	190 - 200	55 - 70
Rice pudding	170 - 190	45 - 60
Apple cake, made of sponge cake mixture (round cake tin)	160 - 170	70 - 80
White bread	190 - 200	55 - 70







### 11.34 Information for test institutes







Tests according to: EN 60350, IEC 60350.

 <b>BAKING ON ONE LEVEL. Baking in tins</b>					
		 (°C)	 (min)		
Fatless sponge cake	True Fan Cooking	140 - 150	35 - 50	2	
Fatless sponge cake	Conventional Cooking	160	35 - 50	2	
Apple pie, 2 tins Ø20 cm	True Fan Cooking	160	60 - 90	2	
Apple pie, 2 tins Ø20 cm	Conventional Cooking	180	70 - 90	1	

 <b>BAKING ON ONE LEVEL. Biscuits</b>					
 <b>Use the third shelf position.</b>					
		 (°C)	 (min)		
Short bread / Pastry strips	True Fan Cooking	140	25 - 40		
Short bread / Pastry strips, preheat the empty oven	Conventional Cooking	160	20 - 30		
Small cakes, 20 per tray, preheat the empty oven	True Fan Cooking	150	20 - 35		
Small cakes, 20 per tray, preheat the empty oven	Conventional Cooking	170	20 - 30		

 <b>MULTILEVEL BAKING. Biscuits</b>					
		 (°C)	 (min)		
				2 positions	3 positions
Short bread / Pastry strips	True Fan Cooking	140	25 - 45	1 / 4	1 / 3 / 5







 MULTILEVEL BAKING. Biscuits					
		 (°C)	 (min)	 2 posi- tions    3 posi- tions	
Small cakes, 20 per tray, preheat the empty oven	True Fan Cooking	150	23 - 40	1 / 4	-







 GRILL				
 Preheat the empty oven for 5 minutes.				
 Grill with the maximum temperature setting.				
		 (min)		
Toast	Grill	1 - 3	5	
Beef steak, turn halfway through	Grill	24 - 30	4	

### 11.35 Information for test institutes

Tests according to IEC 60350.

Tests for the function: Full Steam.

 Set the temperature to 99 °C.					
	 Container (Gastronorm)	 (g)		 (min)	
Broccoli, pre-heat the empty oven	1 x 2/3perforated	300	3	13 - 15	Put the baking tray on the first shelf position.

 Set the temperature to 99 °C.					
	 Container (Gastronorm)	 (g)		 (min)	
Broccoli, pre-heat the empty oven	2 x 2/3 perforated	2 x 300	2 and 4	13 - 15	Put the baking tray on the first shelf position.
Broccoli, pre-heat the empty oven	1 x 2/3 perforated	max.	3	15 - 18	Put the baking tray on the first shelf position.
Peas, frozen	2 x 2/3 perforated	2 x 1500	2 and 4	Until the temperature in the coldest spot reaches 85 °C.	Put the baking tray on the first shelf position.

## 12. CARE AND CLEANING



**WARNING!**  
Refer to Safety chapters.

### 12.1 Notes on cleaning



#### Cleaning Agents

Clean the front of the oven with a soft cloth with warm water and a mild cleaning agent.

To clean metal surfaces, use a dedicated cleaning agent.

Clean stubborn stains with a special oven cleaner.

Use a few drops of vinegar to clean the bottom of the cavity from lime-scale.



#### Everyday Use

Clean the oven cavity after each use. Fat accumulation or other food remains may cause fire. The risk is higher for the grill pan.

Dry the cavity with a soft cloth after each use.



### Accessories

Clean all accessories after each use and let them dry. Use a soft cloth with warm water and a cleaning agent. Do not clean the accessories in a dishwasher.

Do not clean the non-stick accessories using aggressive agents, sharp-edged objects or in a dishwasher.

## 12.2 How to remove: shelf supports

Before maintenance, make sure that the oven is cool. There is a risk of burns.

To clean the oven, remove the shelf supports.

1. Pull carefully the supports up and out of the front catch.

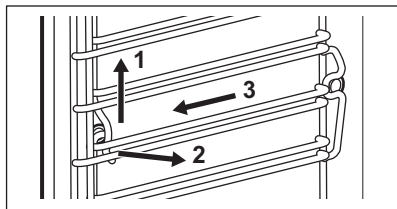

2. Pull the front end of the shelf support away from the side wall.
3. Pull the supports out of the rear catch.

Install the shelf supports in the opposite sequence.

## 12.3 Steam Cleaning

Remove as much dirt as possible manually.

Remove the accessories and the shelf support to clean the side walls.

The steam cleaning functions support the steam cavity cleaning of the oven.

Before you start a cleaning procedure, make sure that the oven is cool.

When the steam cleaning function works, the light is off.

1. Fill the water drawer to the maximum level.
2. Choose the steam cleaning function in the menu: Cleaning.

**Steam Cleaning** - the duration of the function is around 30 minutes.

- a) Turn on the function.

- b) When the programme ends a signal sounds.
- c) Press a sensor field to turn off the signal.

**Steam Cleaning Plus** - the duration of the function is around 75 minutes.

- a) Spray a suitable detergent uniformly in the oven cavity on both enamel and steel parts.
- b) Turn on the function.  
The first part of the programme ends after around 50 minutes.
- c) Press **OK**.

**i** Follow the message in the display to complete the cleaning.

- d) Wipe the cavity of the oven with a non-abrasive surface care sponge. You can use warm water or oven detergents.
- e) Press **OK**.  
The final part of the procedure starts. The duration of this stage is around 25 minutes.

3. Wipe the cavity of the oven with a non-abrasive sponge. You can use warm water.

4. Remove the remaining water from the water drawer.

After cleaning keep the oven door open for approximately 1 hour. Wait until the oven is dry. To speed up the drying you can heat up the oven with hot air at temperature 150 °C for approximately 15 minutes. You can get maximum effects of the cleaning function if you manually clean the oven immediately after the function ends.

## 12.4 Cleaning Reminder

When reminder is displayed cleaning is necessary. Use the function Steam Cleaning Plus.

You can enable / disable the function:  
Cleaning Reminder in the menu: Basic  
Settings.

## 12.5 Cleaning the water drawer

Remove the water drawer from the oven.

1. Remove the lid of the water drawer.  
Lift the cover in correspondence with the protrusion in the rear.

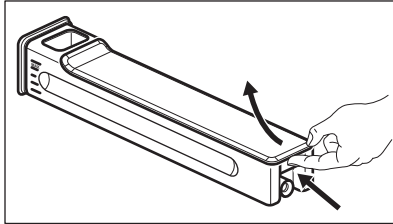

2. Remove the wave-breaker. Pull it away from the drawer body until it snaps out.
3. Wash the water drawer parts with your hands. Use tap water and soap. Do not use abrasive sponges. Do not put water drawer inside a dishwasher.

After you clean the water drawer parts, reassemble the water drawer.

1. Snap in the wave-breaker. Push it into the drawer body.
2. Assemble the lid. First insert the front snap and then push it against the drawer body.

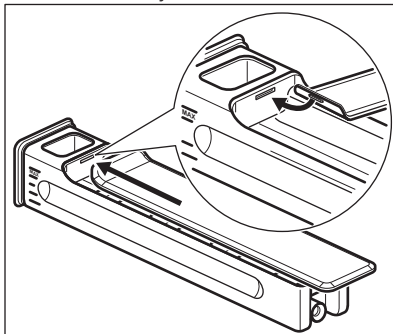

3. Insert the water drawer inside the appliance.
4. Push the water drawer towards the oven until it latches.

## 12.6 Steam generation system - Descaling

When the steam generator operates, limestone accumulates inside it (because of calcium contents in the water). This can have a negative effect on the steam quality, on the performance of the steam generator and on the food quality. To prevent limestone accumulation, clean the steam generation circuit.

Remove all accessories.

Select the function from the menu: Cleaning. The user interface will guide you through the procedure.

The duration of the complete procedure is about 2 hours.

The light in this function is off.

1. Put the grill- / roasting pan on the first shelf position.
2. Press **OK**.
3. Put 250 ml of the descaling agent in the water drawer.
4. Fill the remaining part of the water drawer with water to the maximum level.
5. Insert the water drawer.
6. Press **OK**.

This activates the first part of the procedure: Descaling.

**i** The duration of this part is around 1 hour 40 minutes.

7. After the end of the first part, empty the grill- / roasting pan and put it on the first shelf position again.
8. Press **OK**.
9. Fill the water drawer with fresh water. Make sure there is no remaining cleaning solution inside the water drawer.
10. Insert the water drawer.
11. Press **OK**.

This activates the second part of the procedure: Descaling. It will rinse the steam generation circuit.

**i** The duration of this part is around 35 minutes.

Remove the grill- / roasting pan after the end of the procedure.

- i** If the function: Descaling is not performed in the correct way, the display will show a message to repeat it.

If the oven is humid or wet, wipe it out with a dry cloth. Let the oven dry fully with the door open.

## 12.7 Descaling reminder

There are two descaling reminders which remind you to perform the function: Descaling. These reminders activate each time you switch off the appliance.

The soft reminder reminds and recommends you to perform the descaling cycle.

The hard reminder obligates you to perform the descaling.

- i** If you do not descale the appliance when the hard reminder is on, you cannot use the steam functions. You cannot disable the descaling reminder.

## 12.8 Steam generation system - Rinsing

Remove all accessories.

Select the function from the menu: Cleaning. The user interface will guide you through the procedure.

The duration of the function is around 30 minutes.

The light in this function is off.

1. Put the baking tray on the first shelf position.
  2. Press **OK**.
  3. Fill the water drawer with fresh water.
  4. Press **OK**.
- Remove the baking tray after the end of the procedure.

## 12.9 Removing and installing the door

You can remove the door and the internal glass panels to clean it. The

number of glass panels is different for different models.



### WARNING!

The door is heavy.

1. Open the door fully.
2. Fully press the clamping levers (A) on the two door hinges.

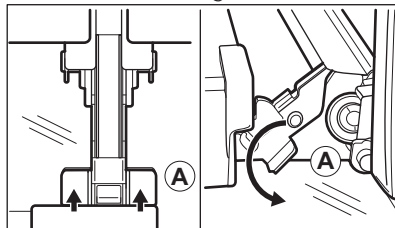

3. Close the oven door to the first opening position (approximately 70° angle).
4. Hold the door with one hand on each side and pull it away from the oven at an upwards angle.
5. Put the door with the outer side down on a soft cloth on a stable surface.
6. Hold the door trim (B) on the top edge of the door at the two sides and push inwards to release the clip seal.

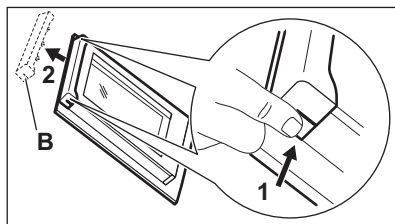

7. Pull the door trim to the front to remove it.
8. Hold the door glass panels on their top edge one by one and pull them up out of the guide.

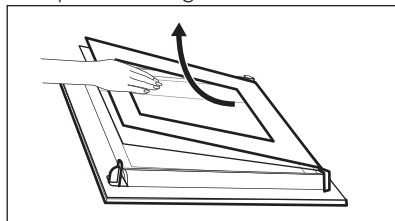

9. Clean the glass panel with water and soap. Dry the glass panel carefully.

When the cleaning is completed, do the above steps in the opposite sequence. Install the smaller panel first, then the larger and the door.



**WARNING!**

Make sure that the glasses are inserted in the correct position otherwise the surface of the door may overheat.

## 12.10 Replacing the lamp



**WARNING!**

Risk of electric shock.  
The lamp can be hot.

1. Turn off the oven.  
Wait until the oven is cooled down.
2. Disconnect the oven from the mains.
3. Put a cloth on the bottom of the cavity.

### The top lamp

1. Turn the lamp glass cover to remove it.

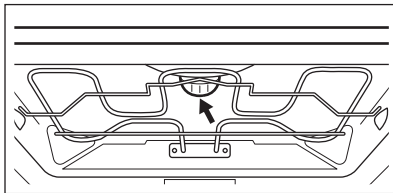

2. Remove the metal ring and clean the glass cover.
3. Replace the lamp with a suitable 300 °C heat-resistant lamp.
4. Attach the metal ring to the glass cover.
5. Install the glass cover.

### The side lamp

1. Remove the left shelf support to get access to the lamp.
2. Use a Torx 20 screwdriver to remove the cover.
3. Remove and clean the metal frame and the seal.
4. Replace the lamp with a suitable 300 °C heat-resistant lamp.
5. Install the metal frame and the seal. Tighten the screws.
6. Install the left shelf support.

## 13. TROUBLESHOOTING



**WARNING!**

Refer to Safety chapters.

### 13.1 What to do if...

Problem	Possible cause	Remedy
You cannot activate or operate the oven.	The oven is not connected to an electrical supply or it is connected incorrectly.	Check if the oven is correctly connected to the electrical supply (refer to the connection diagram if available).
The oven does not heat up.	The oven is turned off.	Turn on the oven.
The oven does not heat up.	The clock is not set.	Set the clock.



Problem	Possible cause	Remedy
The oven does not heat up.	The necessary settings are not set.	Make sure that the settings are correct.
The oven does not heat up.	The automatic switch-off is on.	Refer to "Automatic switch-off".
The oven does not heat up.	The Child Lock is on.	Refer to "Using the Child Lock".
The oven does not heat up.	The fuse is blown.	Make sure that the fuse is the cause of the malfunction. If the fuse is blown again and again, contact a qualified electrician.
The lamp does not operate.	The lamp is defective.	Replace the lamp.
The core temperature sensor does not operate.	The plug of the core temperature sensor is not correctly installed into the socket.	Put the plug of the core temperature sensor as far as possible into the socket.
The display shows F111.	The plug of the core temperature sensor is not correctly installed into the socket.	Put the plug of the core temperature sensor as far as possible into the socket.
The display shows an error code that is not in this table.	There is an electrical fault.	<ul style="list-style-type: none"> <li>• Turn off the oven with the house fuse or the safety switch in the fuse box and turn it on again.</li> <li>• If the display shows the error code again, contact the Customer Care Department.</li> </ul>
Steam and condensation settle on the food and in the cavity of the oven.	You left the dish in the oven for too long.	Do not leave the dishes in the oven for longer than 15 - 20 minutes after the cooking process ends.
The appliance is activated and does not heat up. The fan does not operate. The display shows " <b>Demo</b> ".	The demo mode is activated.	Refer to "Basic Settings" in "Daily use" chapter.
The appliance does not retain the water drawer after you insert it.	You did not assemble the lid of the water drawer correctly.	Assemble the lid of the water drawer correctly.

<b>Problem</b>	<b>Possible cause</b>	<b>Remedy</b>
Water comes out of the water drawer after you carry it or put it inside the appliance.	You did not assemble the lid of the water drawer correctly.	Assemble the lid of the water drawer correctly.
Water comes out of the water drawer after you carry it or put it inside the appliance.	You did not assemble the wave-breaker correctly.	Assemble the wave-breaker in the body of the water drawer correctly.
The appliance does not retain the water drawer after you push it on the cover.	You did not fully press the water drawer body.	Insert the water drawer body in the appliance by pushing it until it reaches to the end.
The water drawer is difficult to clean.	You did not remove the lid and the wave-breaker.	Refer to "Cleaning the water drawer".
The descaling procedure is interrupted before it finishes.	There was a power cut.	Repeat the procedure.
The descaling procedure is interrupted before it finishes.	The function was stopped by the user.	Repeat the procedure.
There is no water inside the grill- / roasting pan after the descaling procedure.	You did not fill the water drawer to the maximum level.	Check if the a descaling agent / water is present in the water drawer body. Repeat the procedure.
There is dirty water on the bottom of the cavity after the descaling cycle.	The grill- / roasting pan is on a wrong shelf position.	Remove the residual water and the descaling agent from the bottom of the oven. Put the grill- / roasting pan on the first shelf position.
The cleaning function is interrupted before it finishes.	There was a power cut.	Repeat the procedure.
The cleaning function is interrupted before it finishes.	The function was stopped by the user.	Repeat the procedure.
There is too much water on the bottom of the cavity after the end of the cleaning function.	You sprayed too much detergent in the appliance before the activation of the cleaning cycle.	Cover all parts of the cavity with a thin layer of the detergent. Spray the detergent evenly.
There is no good performance of the cleaning procedure.	The initial oven cavity temperature of the steam cleaning function was too high.	Repeat the cycle. Run the cycle when the appliance is cold.

Problem	Possible cause	Remedy
There is no good performance of the cleaning procedure.	You did not remove the side grids before the start of the cleaning procedure. They can transfer heat to the walls and decrease the performance.	Remove the side grids from the appliance and repeat the function.
There is no good performance of the cleaning procedure.	You did not remove the accessories from the appliance before the start of the cleaning procedure. They can compromise the steam cycle and decrease the performance.	Remove the accessories from the appliance and repeat the function.

### 13.2 Service data

If you cannot find a solution to the problem yourself, contact your dealer or an Authorised Service Centre.

The necessary data for the service centre is on the rating plate. The rating plate is

on the front frame of the oven cavity. Do not remove the rating plate from the oven cavity.

We recommend that you write the data here:	
Model (MOD.)	.....
Product number (PNC)	.....
Serial number (S.N.)	.....

## 14. ENERGY EFFICIENCY

### 14.1 Product Information and Product Information Sheet\*

Supplier's name	AEG
Model identification	BSE792220B 944187755, 944187759 BSE792220M 944187741, 944187828
Energy Efficiency Index	81.0
Energy efficiency class	A+
Energy consumption with a standard load, conventional mode	0.99 kWh/cycle

Energy consumption with a standard load, fan-forced mode	0.68 kWh/cycle	
Number of cavities	1	
Heat source	Electricity	
Volume	70 l	
Type of oven	Built-In Oven	
Mass	BSE792220B	39.5 kg
	BSE792220M	39.5 kg

\* For European Union according to EU Regulations 65/2014 and 66/2014.  
 For Republic of Belarus according to STB 2478-2017, Appendix G; STB 2477-2017, Annexes A and B.  
 For Ukraine according to 568/32020.

Energy efficiency class is not applicable for Russia.

EN 60350-1 - Household electric cooking appliances - Part 1: Ranges, ovens, steam ovens and grills - Methods for measuring performance.

## 14.2 Energy saving



The oven contains features which help you save energy during everyday cooking.

Make sure that the oven door is closed properly when the oven operates. Do not open the door too often during cooking. Keep the door gasket clean and make sure it is well fixed in its position.

Use metal cookware to improve energy saving.

When possible, do not preheat the oven before cooking.

Keep breaks between baking as short as possible when you prepare a few dishes at one time.

### Cooking with fan

When possible, use the cooking functions with fan to save energy.

### Residual heat

If a programme with the Duration or End Time selection is activated and the cooking time is longer than 30 minutes, the heating elements automatically turn off earlier in some oven functions.

The fan and lamp continue to operate. When you turn off the oven, the display shows the residual heat. You can use that heat to keep the food warm.

When the cooking duration is longer than 30 minutes, reduce the oven temperature to minimum 3 - 10 minutes before the end of cooking. The residual heat inside the oven will continue to cook.

Use the residual heat to warm up other dishes.

### Keep food warm

Choose the lowest possible temperature setting to use residual heat and keep a meal warm. The residual heat indicator or temperature appears on the display.

### Cooking with the lamp off

Turn off the lamp during cooking. Turn it on only when you need it.

### Moist Fan Baking

Function designed to save energy during cooking.

When you use this function the lamp automatically turns off after 30 seconds. You may turn on the lamp again but this action will reduce the expected energy savings.

## 15. ENVIRONMENTAL CONCERNS

Recycle materials with the symbol . Put the packaging in relevant containers to recycle it. Help protect the environment and human health by recycling waste of electrical and electronic appliances. Do not dispose of

appliances marked with the symbol  with the household waste. Return the product to your local recycling facility or contact your municipal office.





[www.aeg.com/shop](http://www.aeg.com/shop)



867 353835-A-282019



**AEG**